

FOOTNOTES

Figure 1

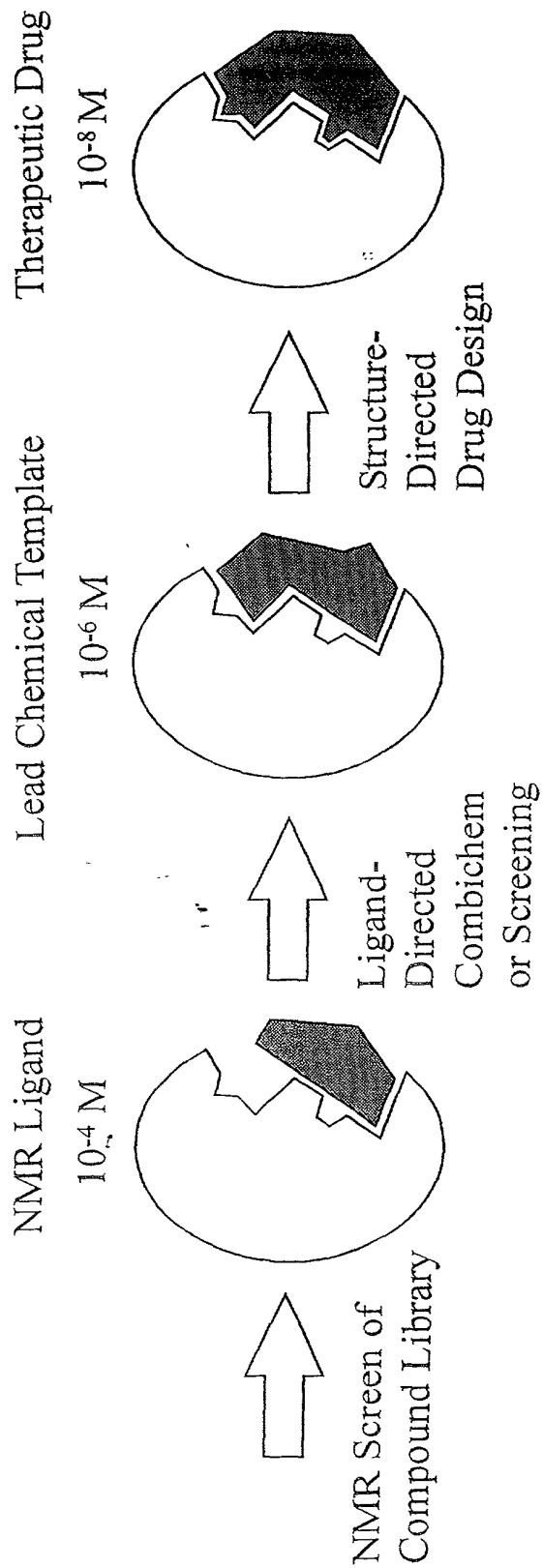
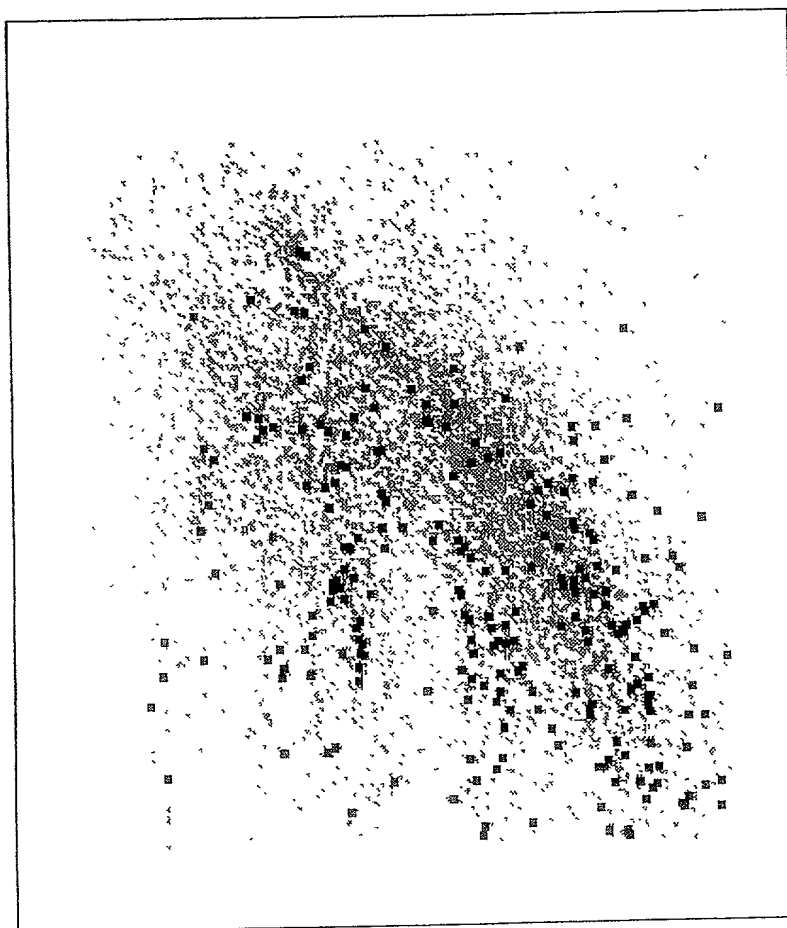

Figure 2



HA BCUT

CHRG BCUT

Figure 3

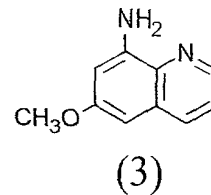
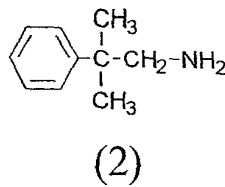
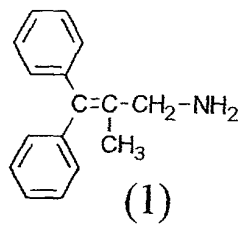

A

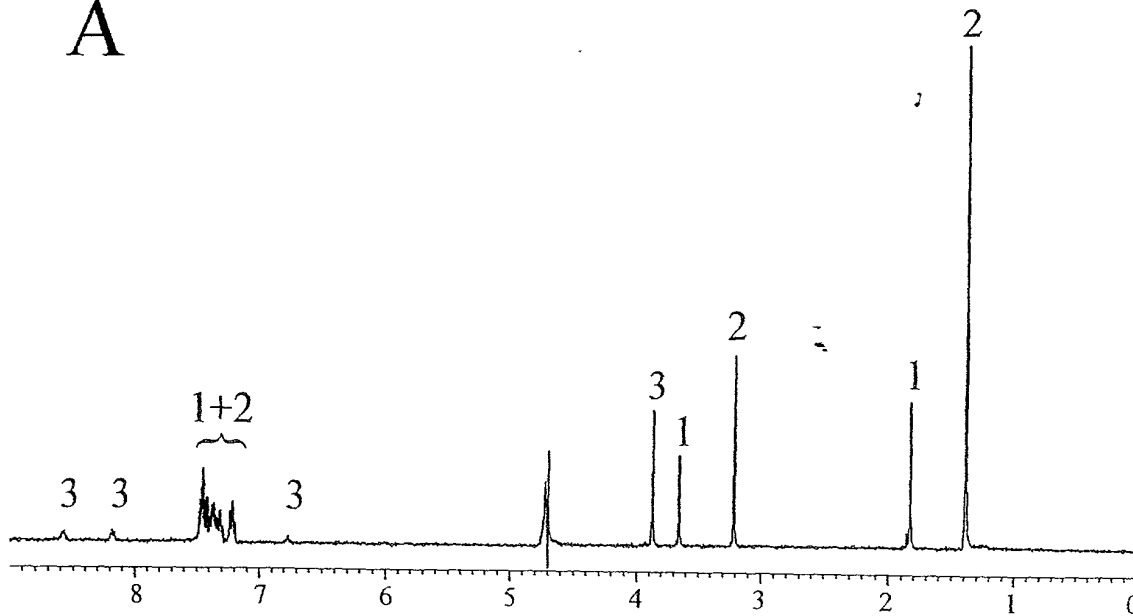

B

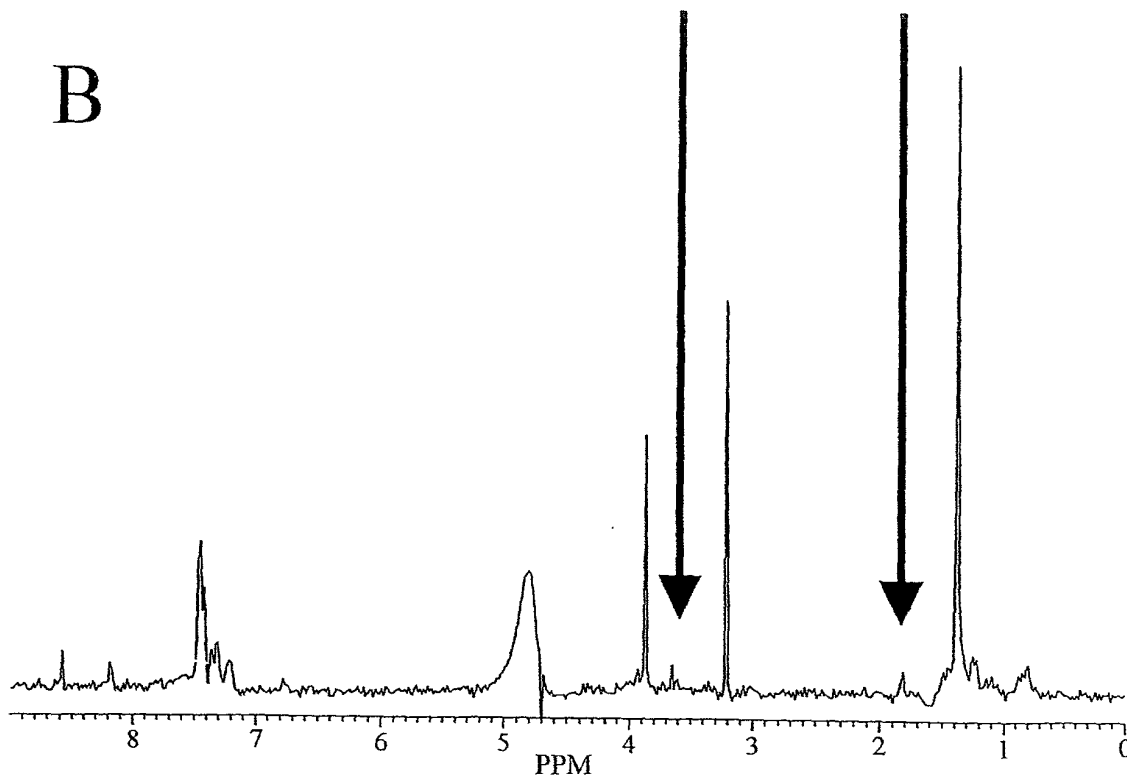

FOR "SECRET"

Figure 4

A

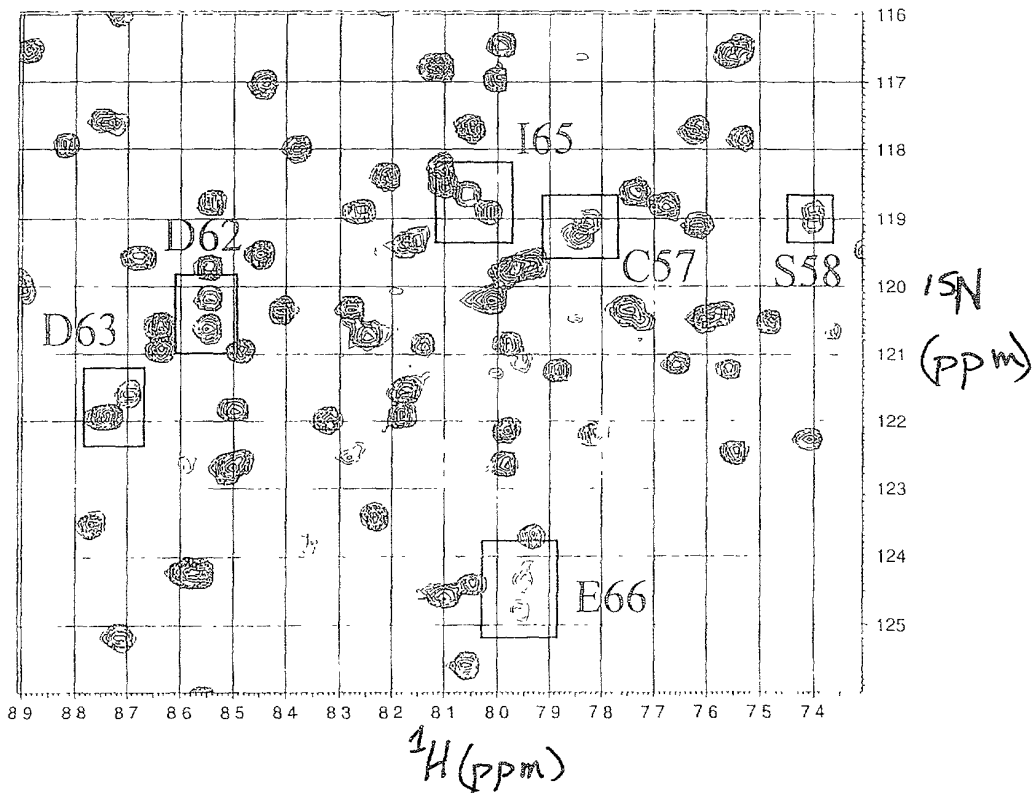

B



FIGURE 4

Figure 5

A

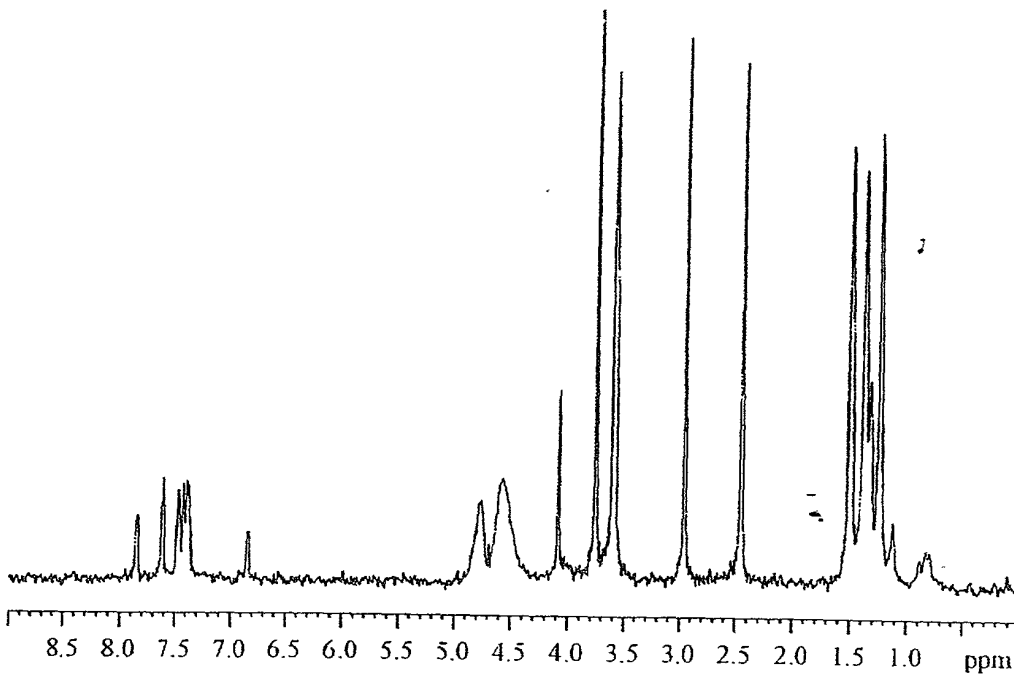

B

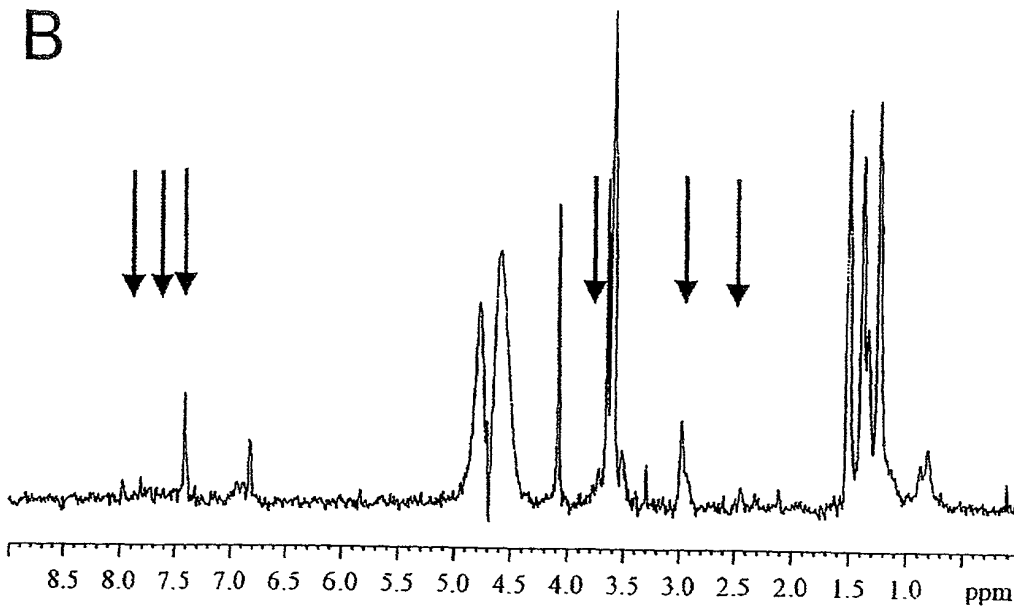

FOR FURTHER INFORMATION CONTACT

Figure 6

FIGURE 6

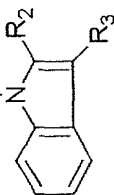

Ligand A  $IC_{50} \sim 9.0 \times 10^{-5} M$

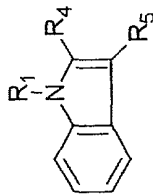

Ligand B  $IC_{50} = 1.8 \times 10^{-5} M$

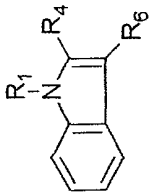

Ligand C  $IC_{50} = 1.8 \times 10^{-5} M$

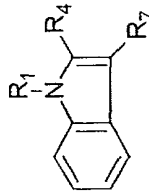

Ligand D  $IC_{50} = 1.2 \times 10^{-5} M$

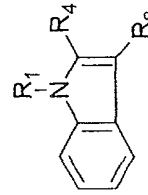

Ligand E  $IC_{50} = 3.2 \times 10^{-6} M$

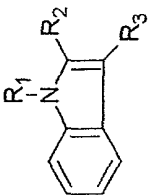

Ligand A NMR  $K_d \sim 1.4 \times 10^{-4} M$

FIGURE 6  
Figure 7

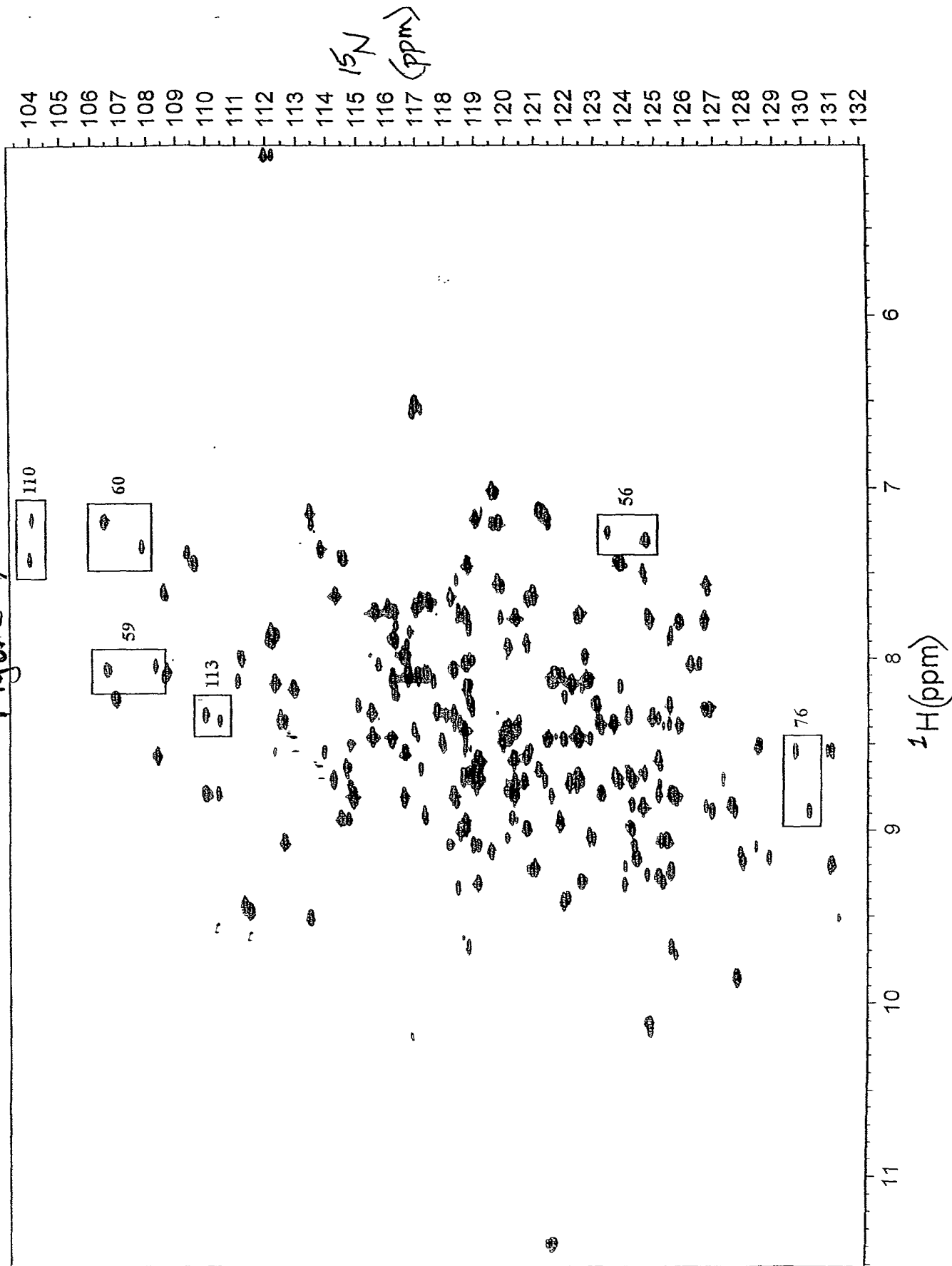

FOOTNOTES  
Figure 8

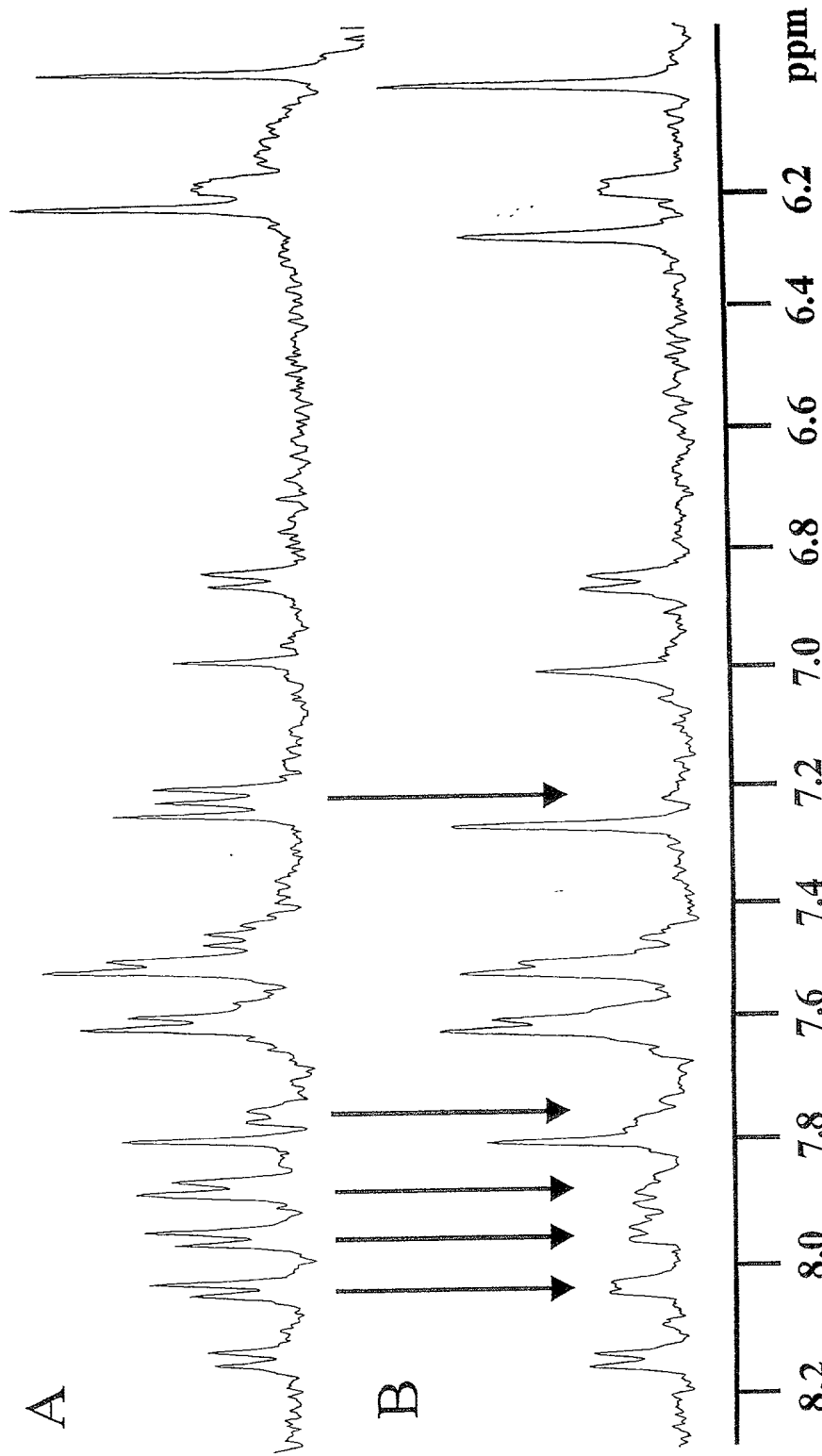



Figure 9

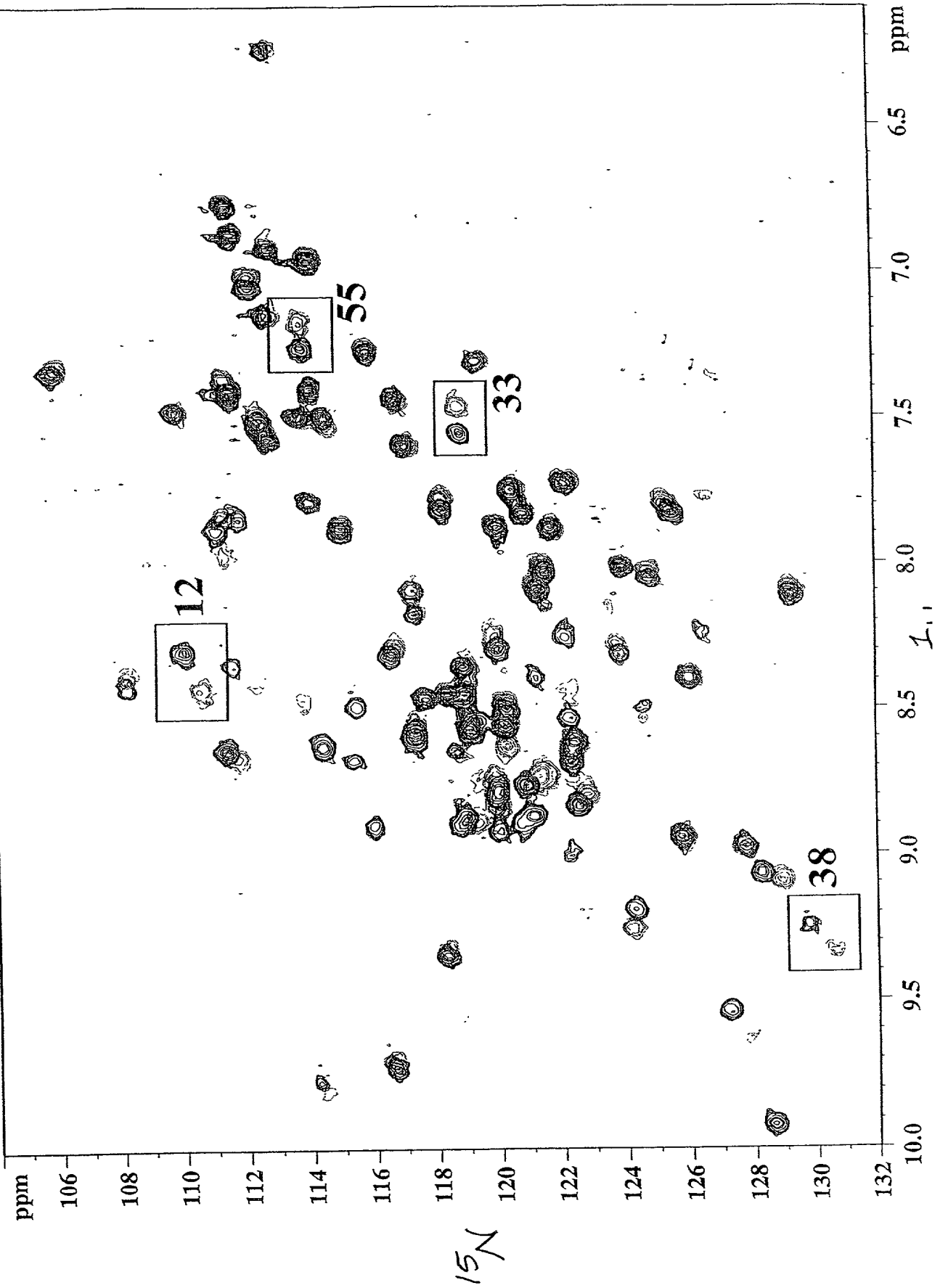
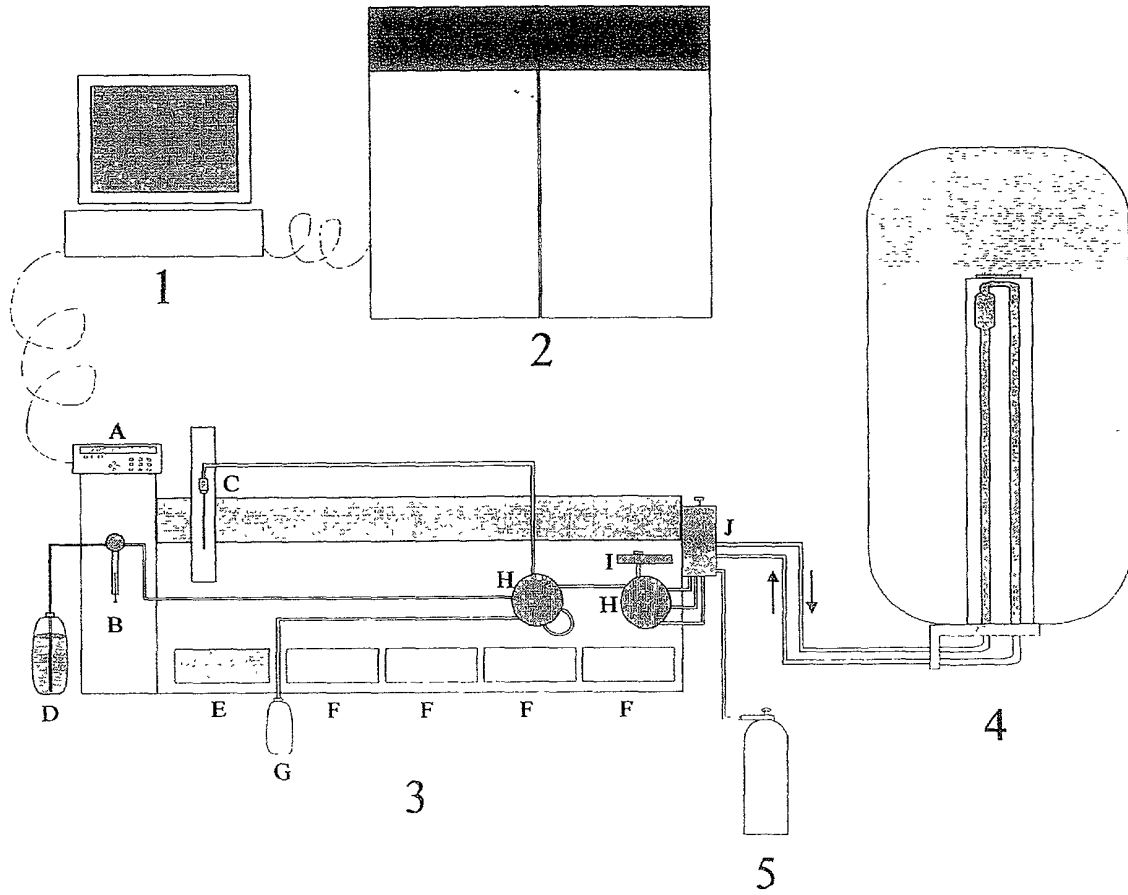
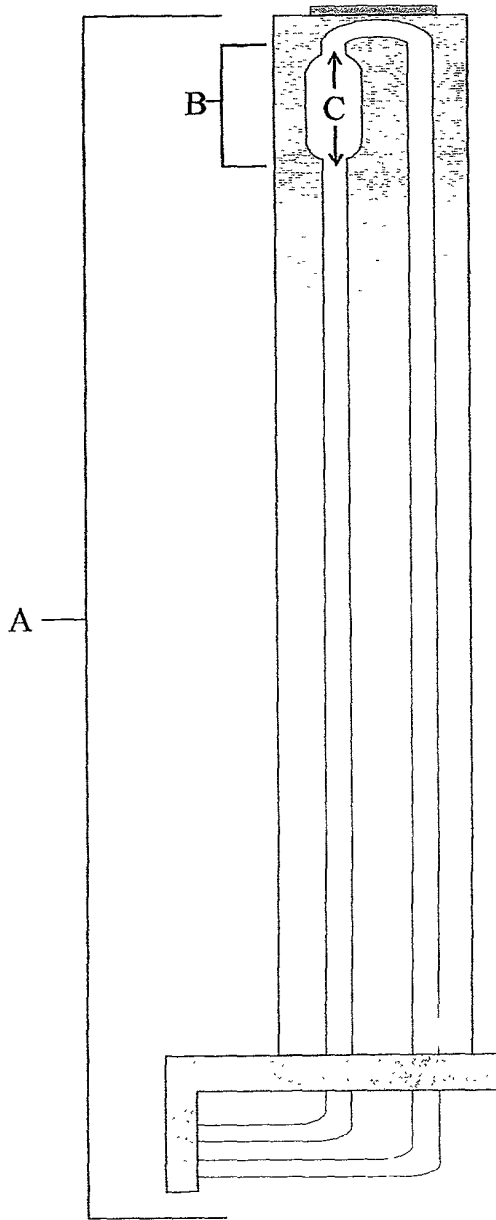

Figure 10.



FOR "OFFICE" USE ONLY

Figure 11.



FOR OFFICIAL USE ONLY

Figure 12.

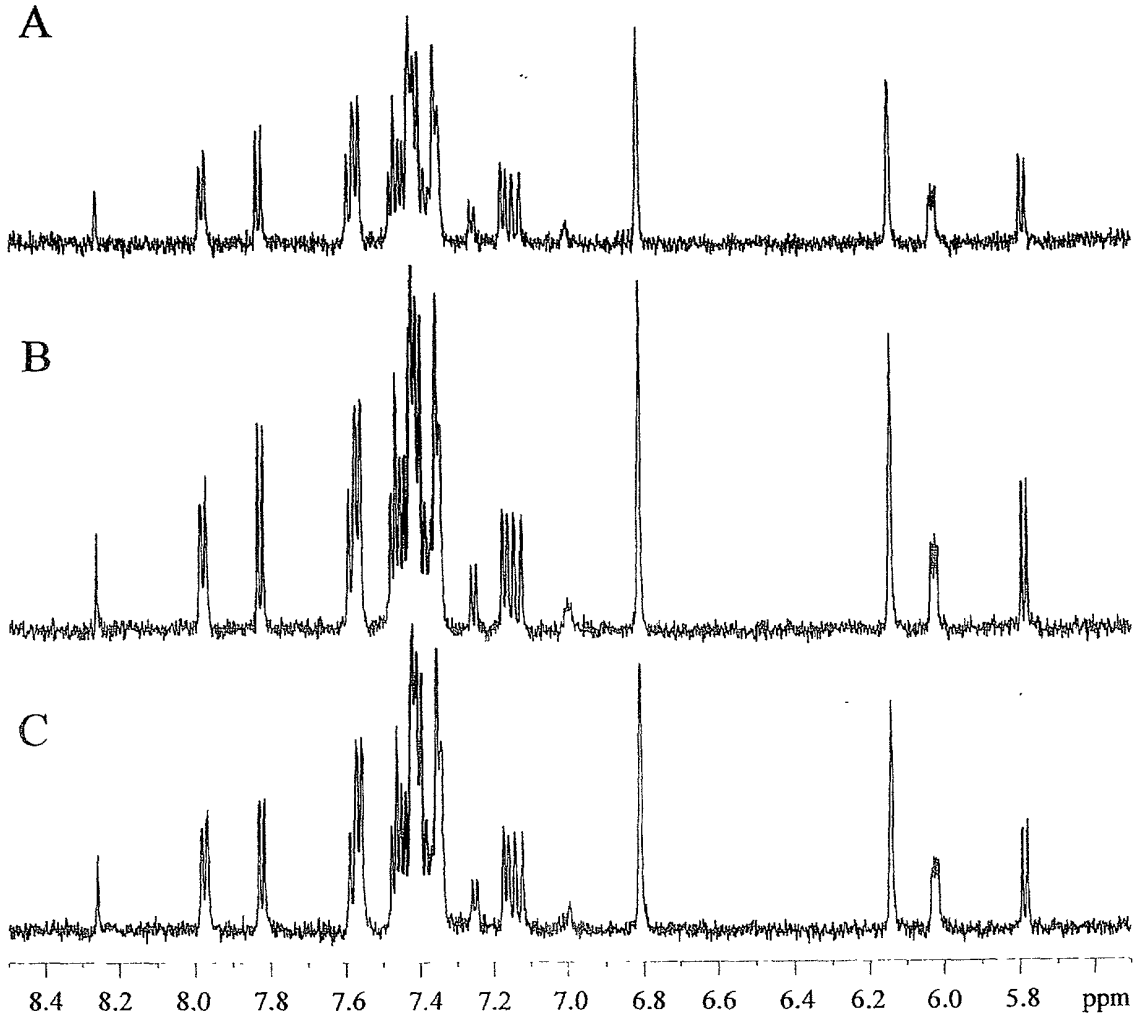
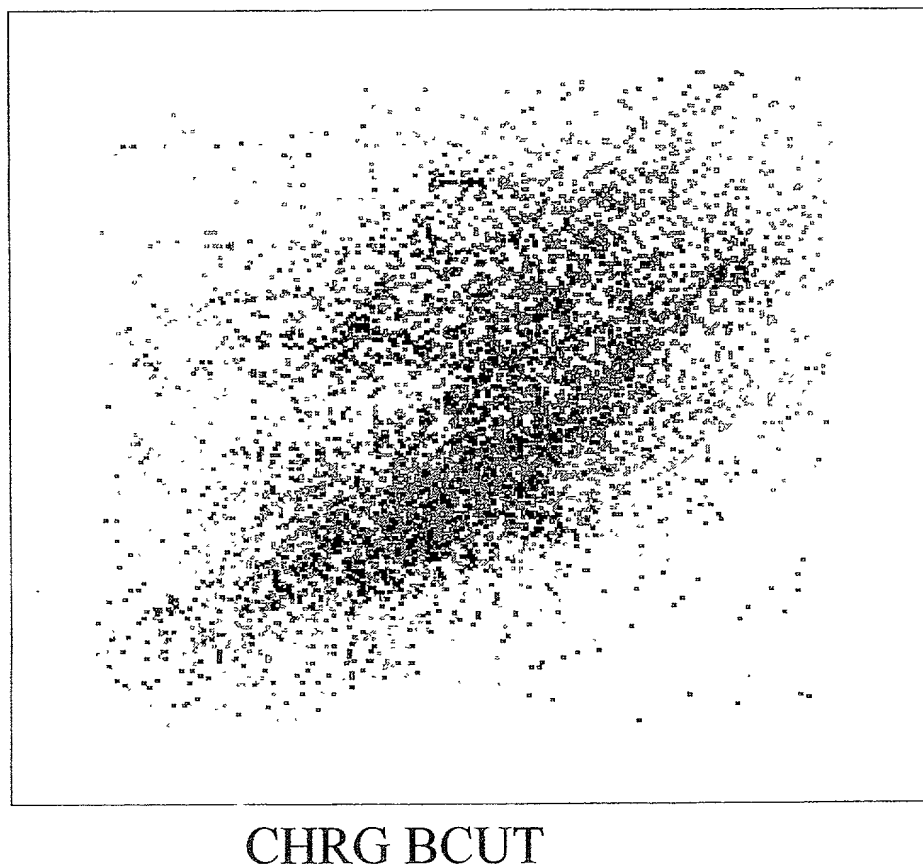
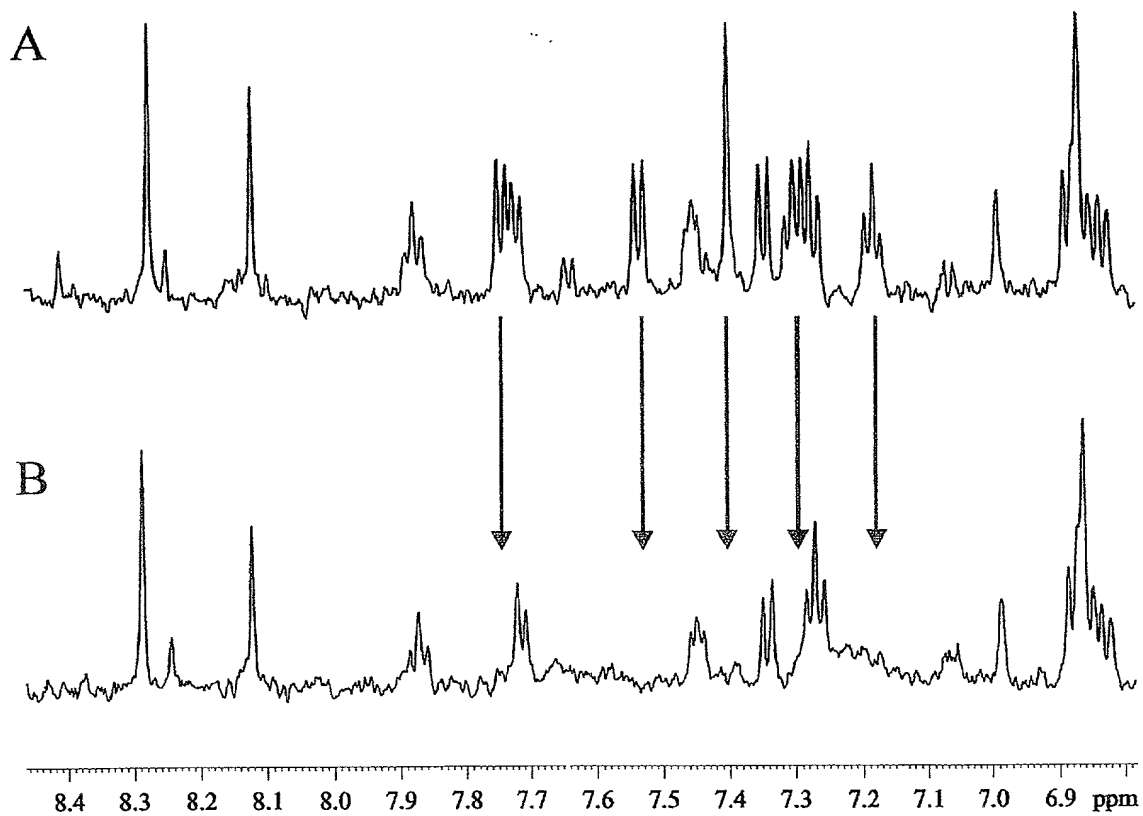

Figure 13.



FOOTNOTES

Figure 14.



DOCKET SHEET

Figure 15

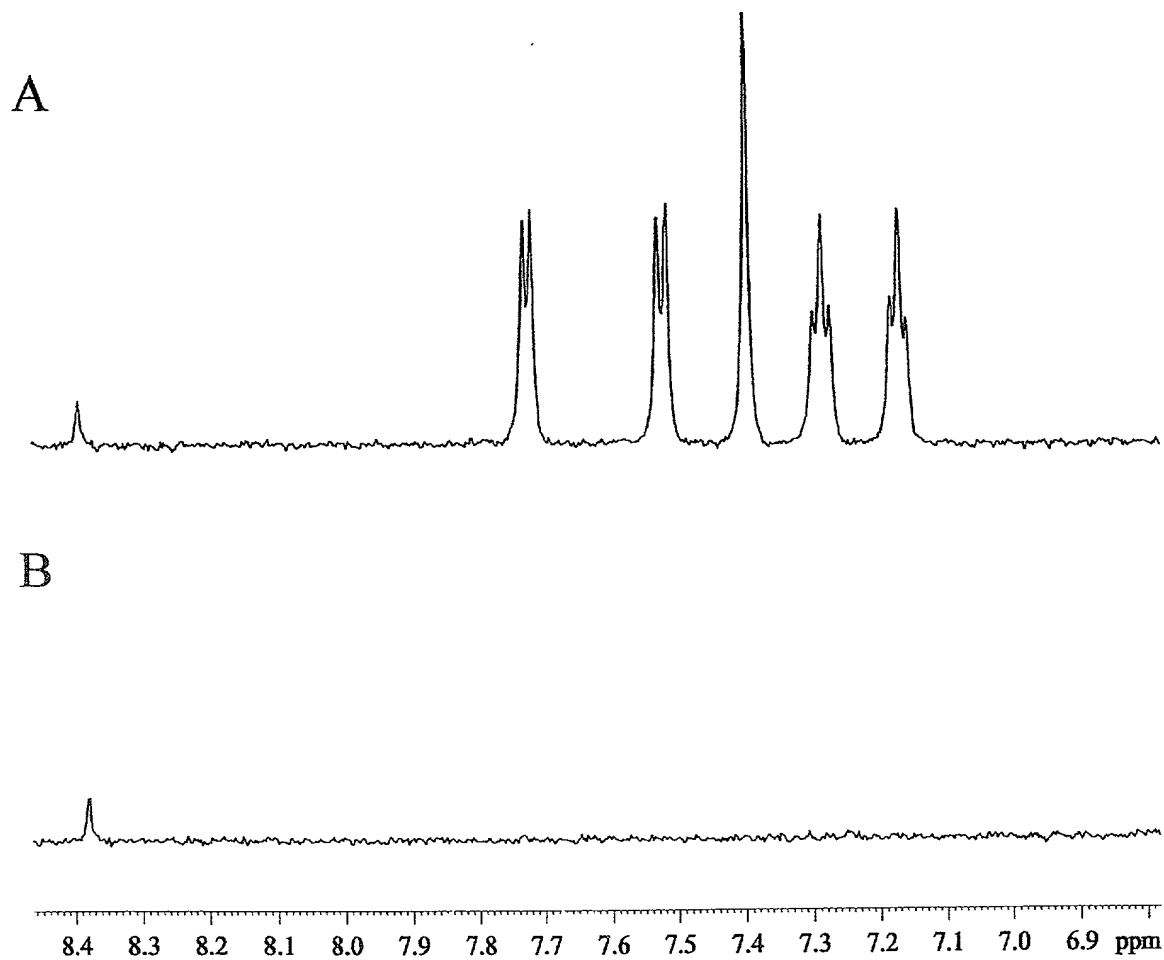
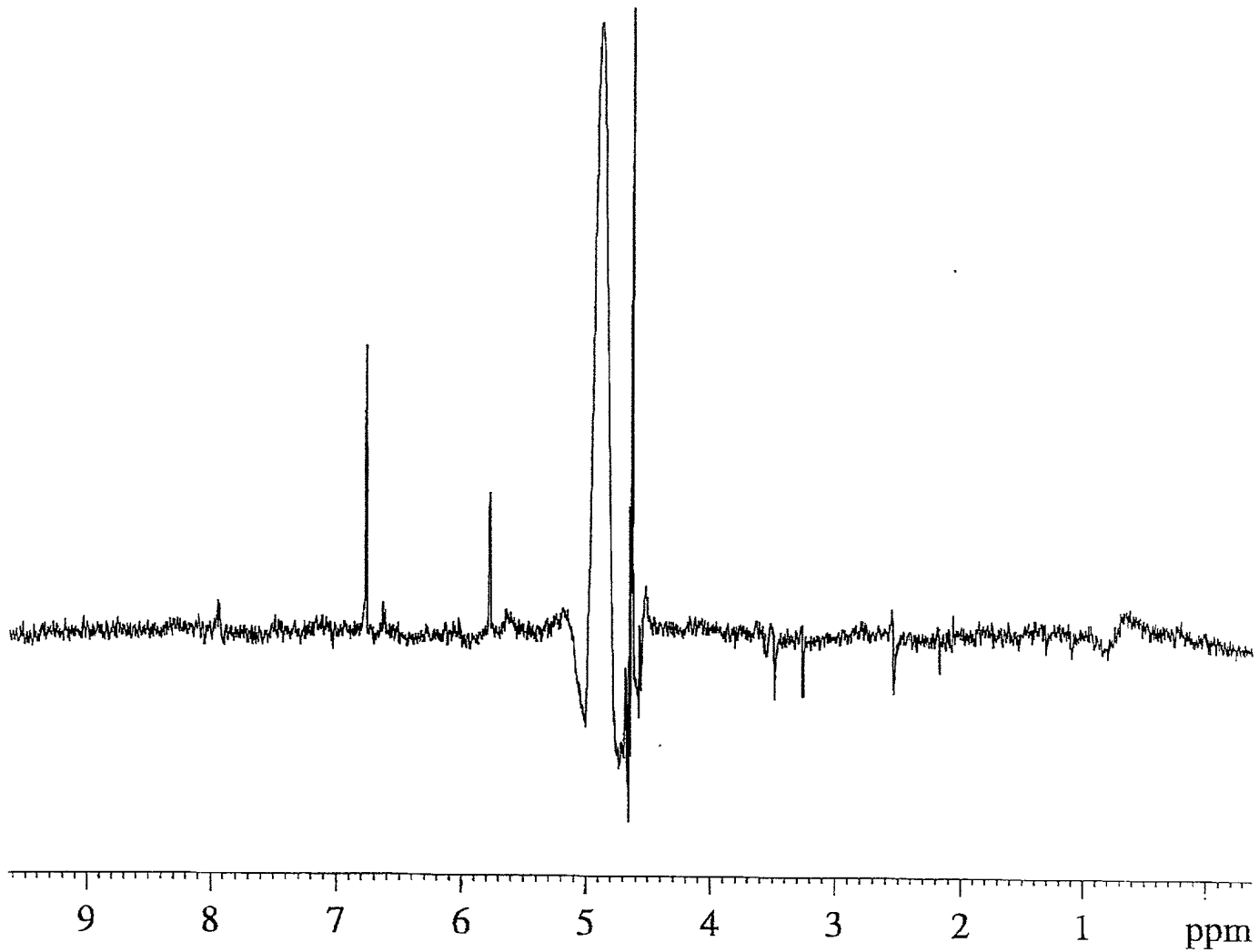

FIGURE 15

Figure 15

FOOTNOTES





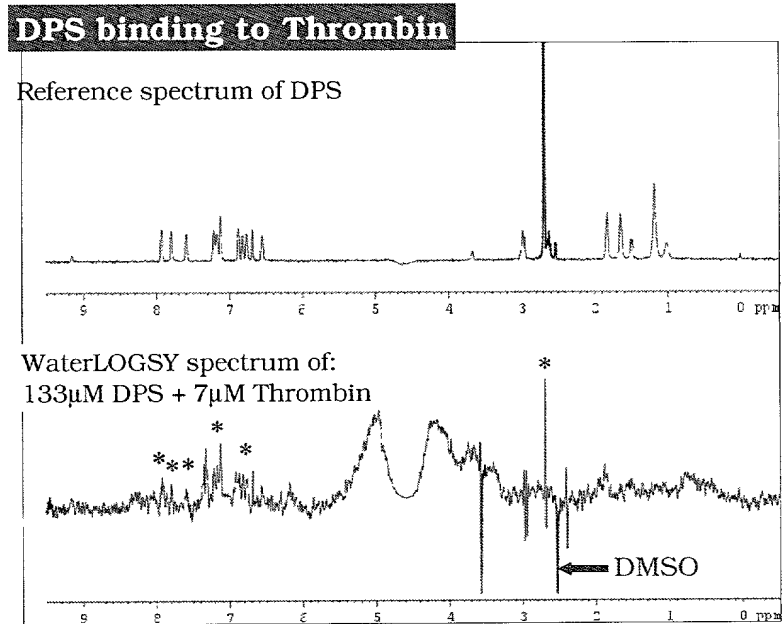

Figure 17

FOOTNOTES